

A01 | 3.5-Zimmer-Wohnung EG | Haus A

Wohnfläche ca. 93.9m²

Wohnfläche: exkl. Aussenwände, inkl. nicht tragende Innenwände

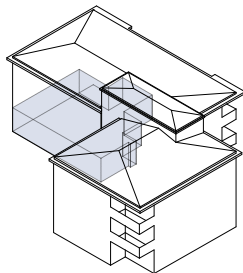
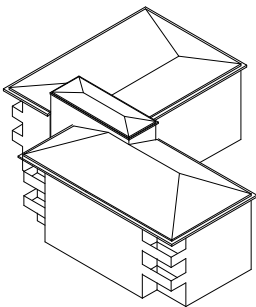
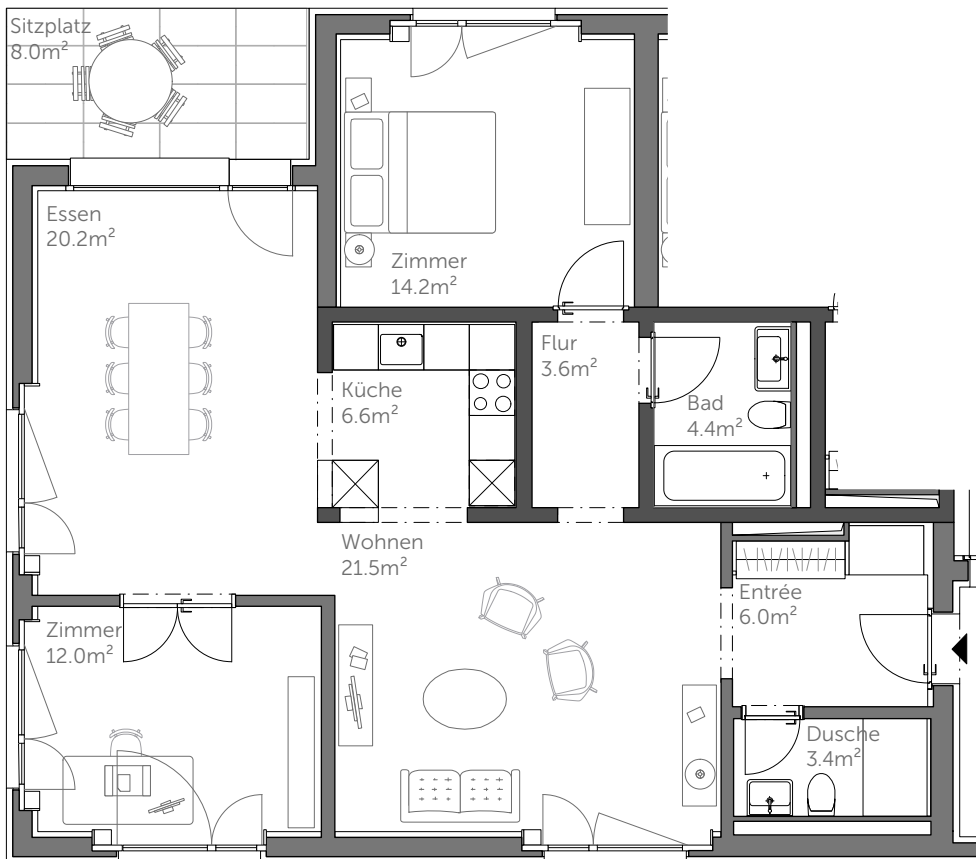
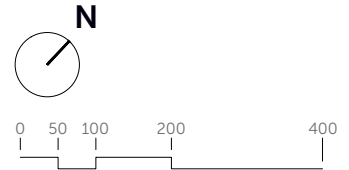

A02 | 2.5-Zimmer-Wohnung EG | Haus A

Wohnfläche ca. 58.1m²

Wohnfläche: exkl. Aussenwände, inkl. nicht tragende Innenwände

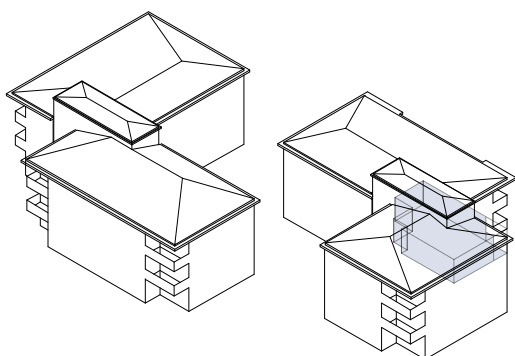
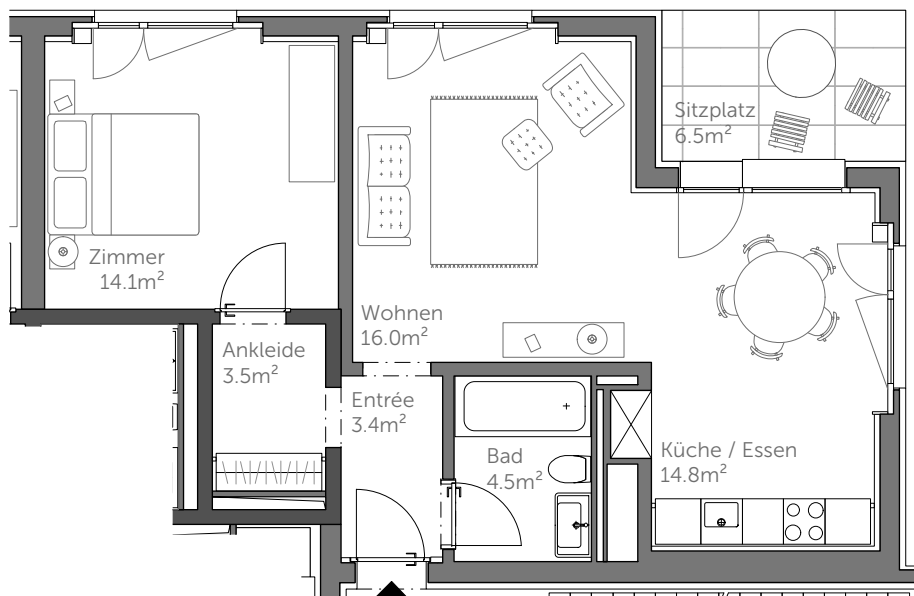
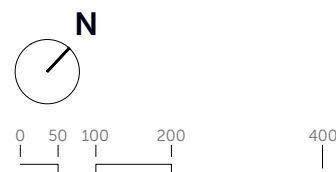

A03 | 4.5-Zimmer-Wohnung EG | Haus A

Wohnfläche ca. 99.2m²

Wohnfläche: exkl. Aussenwände, inkl. nicht tragende Innenwände

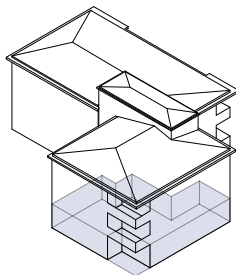
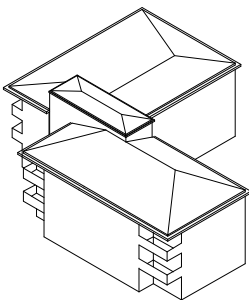
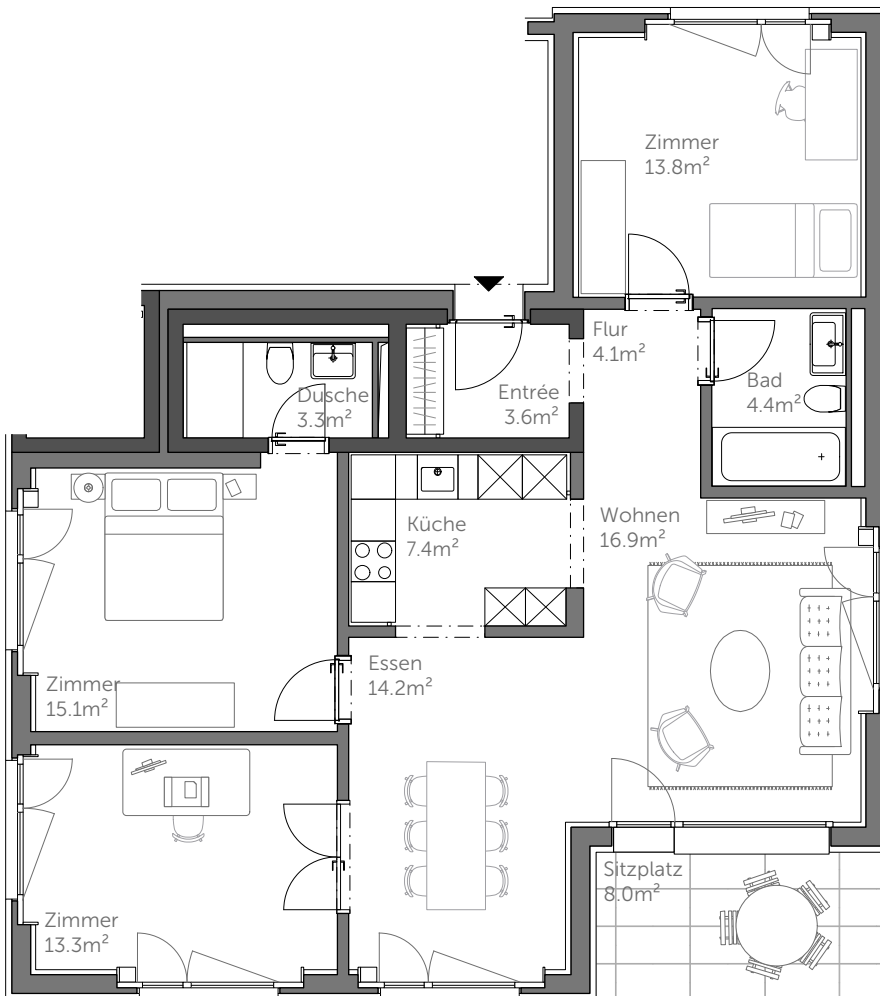
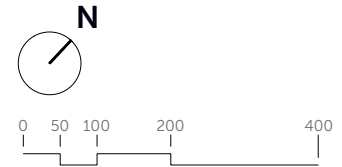

A11 | 3.5-Zimmer-Wohnung 1.OG | Haus A

Wohnfläche ca. 93.3m²

Wohnfläche: exkl. Aussenwände, inkl. nicht tragende Innenwände

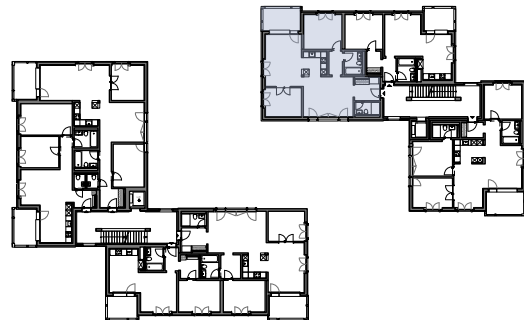
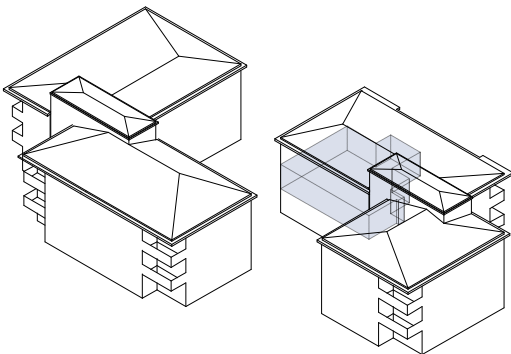
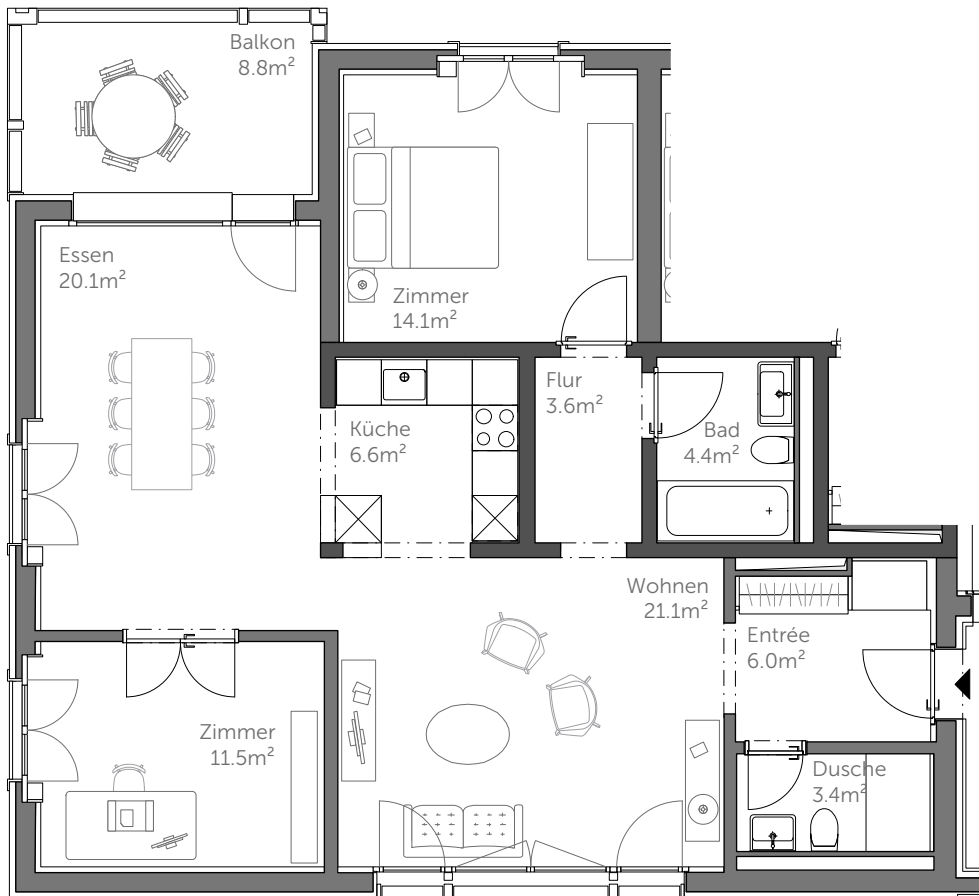
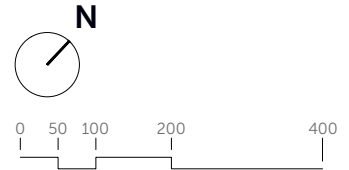

A12 | 2.5-Zimmer-Wohnung 1. OG | Haus A

Wohnfläche ca. 57.8m²

Wohnfläche: exkl. Aussenwände, inkl. nicht tragende Innenwände

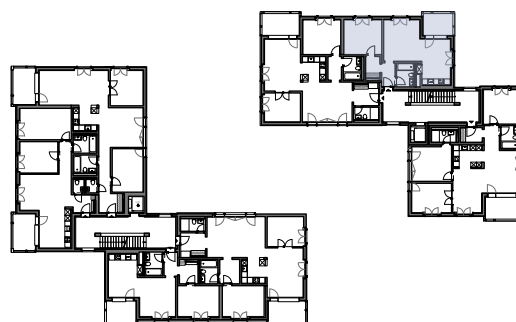
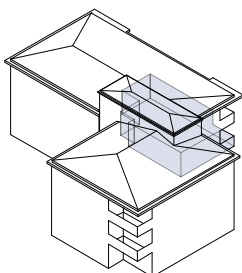
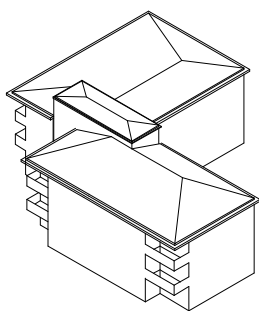
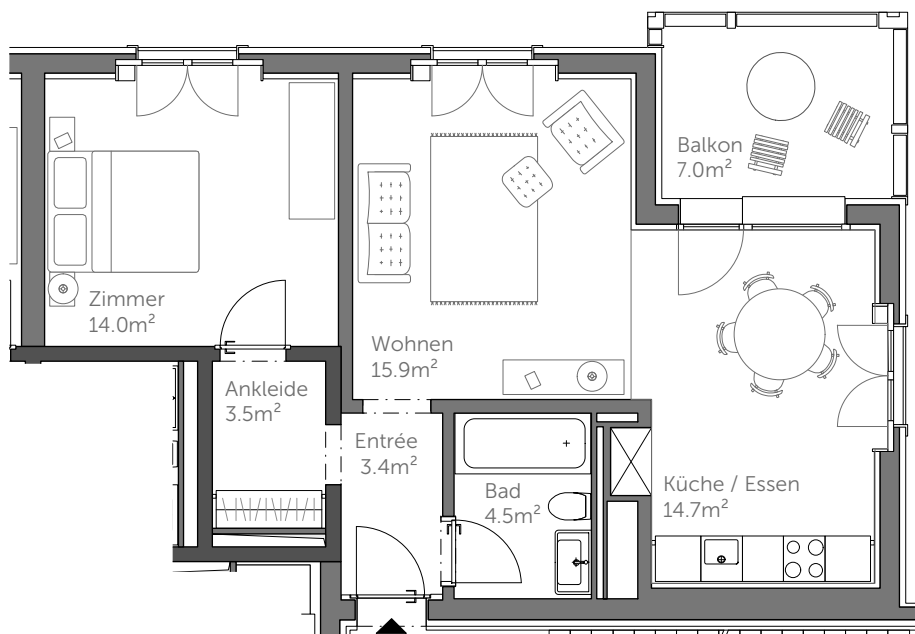
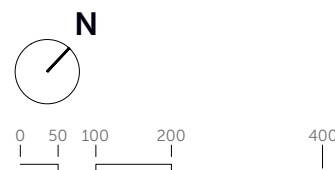

A13 | 4.5-Zimmer-Wohnung 1. OG | Haus A

Wohnfläche ca. 97.8m²

Wohnfläche: exkl. Aussenwände, inkl. nicht tragende Innenwände

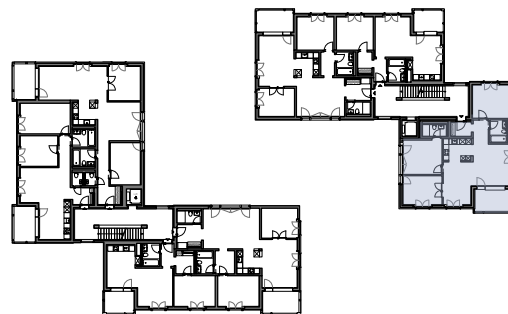
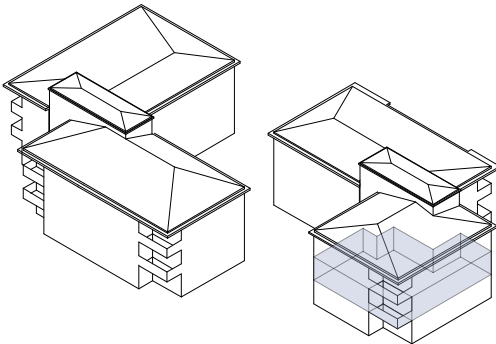
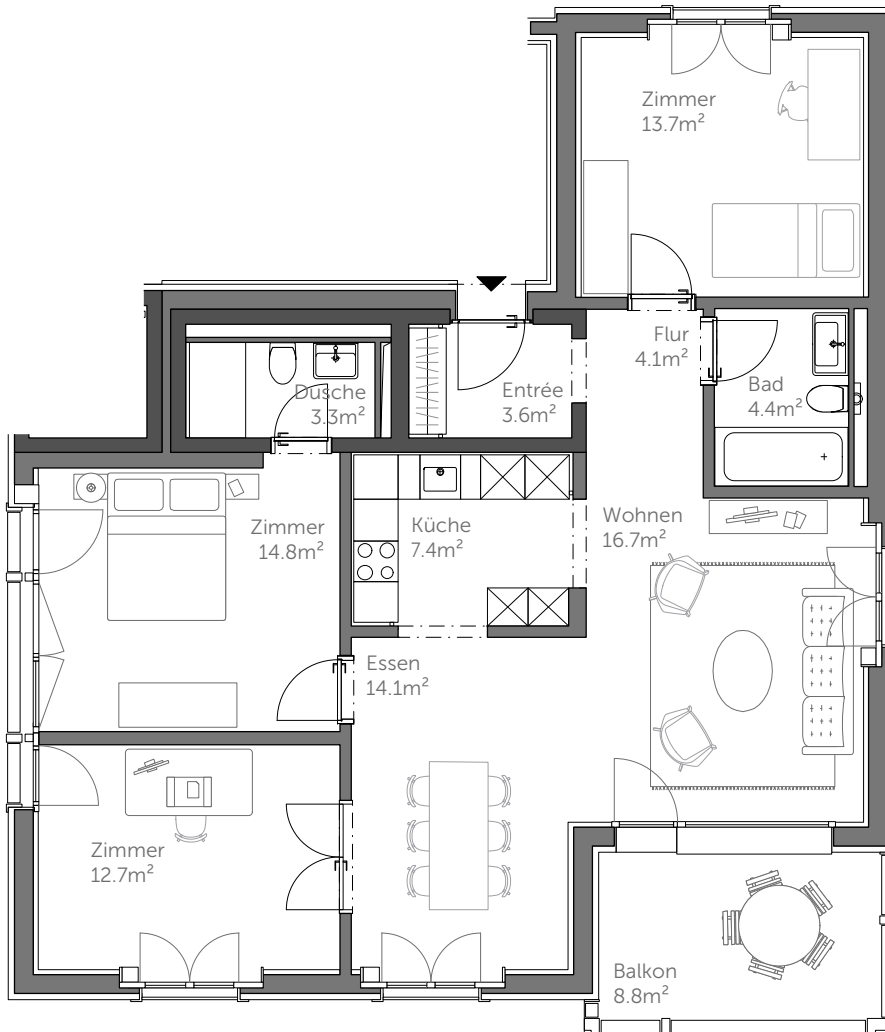
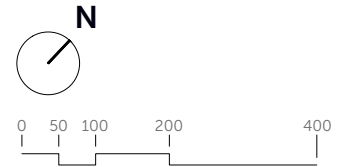

A21 | 3.5-Zimmer-Wohnung 2.OG | Haus A

Wohnfläche ca. 93.3m²

Wohnfläche: exkl. Aussenwände, inkl. nicht tragende Innenwände

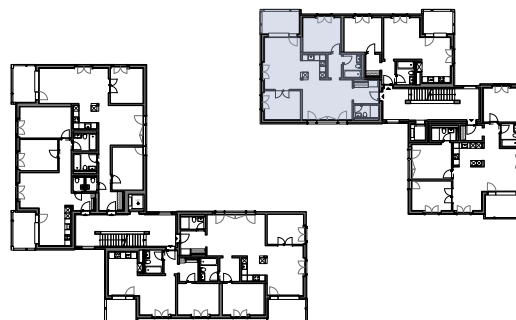
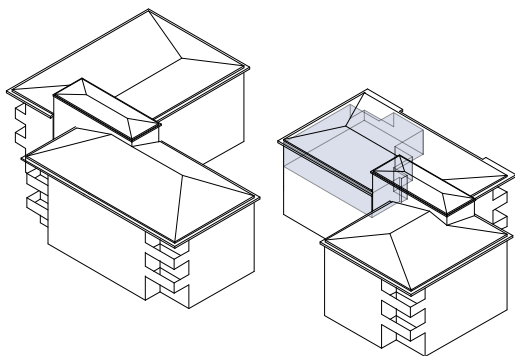
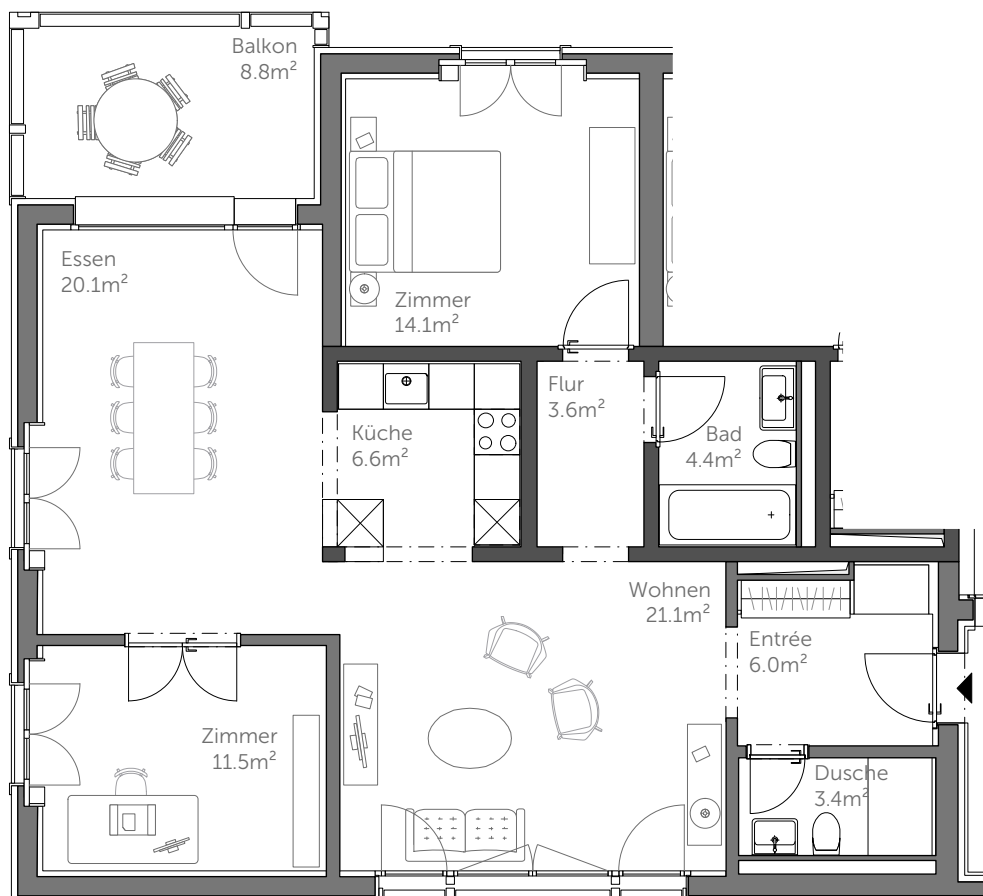
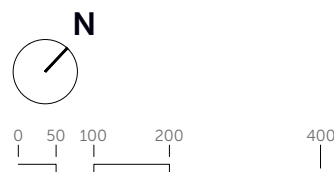

A22 | 2.5-Zimmer-Wohnung 2. OG | Haus A

Wohnfläche ca. 57.8m²

Wohnfläche: exkl. Aussenwände, inkl. nicht tragende Innenwände

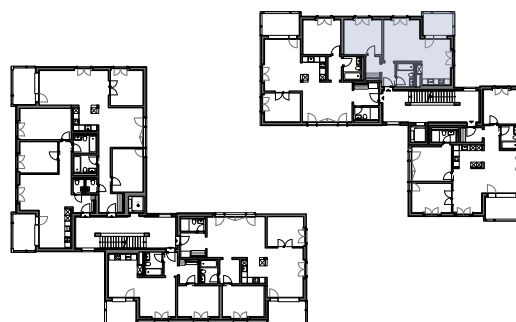
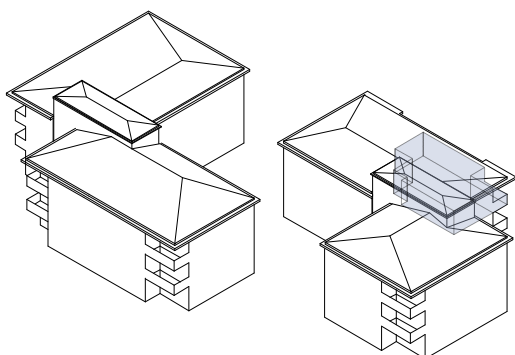
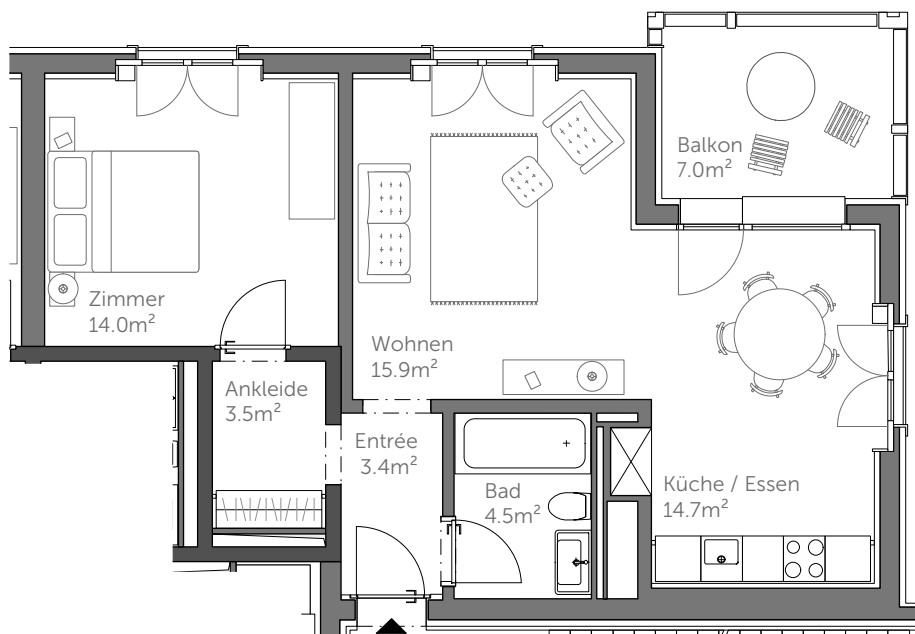
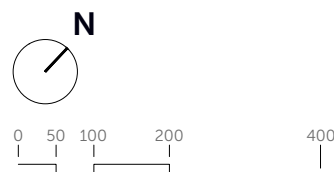

A23 | 4.5-Zimmer-Wohnung 2. OG | Haus A

Wohnfläche ca. 97.8m²

Wohnfläche: exkl. Aussenwände, inkl. nicht tragende Innenwände

